

High Speed Optocoupler, Dual, 5 MBd

Features

- Data Rate 5 MBits/s (2.5 MBit/s over Temperature)
- Buffer
- Isolation Test Voltage, 5300 V_{RMS}
- TTL, LSTTL and CMOS Compatible
- Internal Shield for Very High Common Mode Transient Immunity
- Wide Supply Voltage Range (4.5 to 15 V)
- Low Input Current (1.6 mA to 5.0 mA)
- Specified from 0 °C to 85 °C
- Lead-free component
- Component in accordance to RoHS 2002/95/EC and WEEE 2002/96/EC

Agency Approvals

- UL1577, File No. E52744 System Code H or J, Double Protection

Applications

Industrial Control
 Replace Pulse Transformers
 Routine Logic Interfacing
 Motion/Power Control
 High Speed Line Receiver
 Microprocessor System Interfaces
 Computer Peripheral Interfaces

Description

The dual channel 5 Mb/s SFH6731 and SFH6732 high speed optocoupler consists of a GaAlAs infrared emitting diode, optically coupled with an integrated photo detector. The detector incorporates a Schmitt-Trigger stage for improved noise immunity. A Faraday

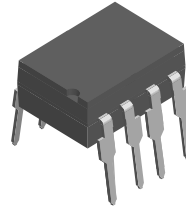

1179075

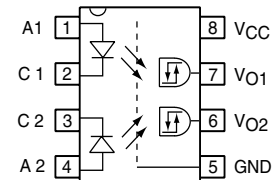

shield provides a common mode transient immunity of 1000 V/μs at V_{CM} = 50 V for SFH6731 and 500 V/μs at V_{CM} = 300 V for SFH6732.

The SFH6731 and SFH6732 uses an industry standard DIP-8 package. With standard lead bending, creepage distance and clearance of ≥ 7.0 mm with lead bending options 6, 7 and 9 ≥ 8.0 mm are achieved.

Order Information

Part	Remarks
SFH6731	CM _H ≥ 1000 @ V _{CM} = 50 V, DIP-8
SFH6732	CM _H ≥ 5000 @ V _{CM} = 300 V, DIP-8
SFH6732-X007	CM _H ≥ 5000 @ V _{CM} = 300 V, SMD-8 (option 7)

For additional information on the available options refer to Option Information.

Truth Table (Positive Logic)

Parts	IR Diode	Output
SFH6731	on	H
	off	L
SFH6732	on	H
	off	L

Absolute Maximum Ratings

$T_{amb} = 25\text{ °C}$, unless otherwise specified

Stresses in excess of the absolute Maximum Ratings can cause permanent damage to the device. Functional operation of the device is not implied at these or any other conditions in excess of those given in the operational sections of this document. Exposure to absolute Maximum Rating for extended periods of the time can adversely affect reliability.

Input

Parameter	Test condition	Symbol	Value	Unit
Reverse voltage		V_R	3.0	V
DC Forward current		I_F	10	mA
Surge forward current	$t_p \leq 1.0\ \mu\text{s}$, 300 pulses/s	I_{FSM}	1.0	A
Power dissipation		P_{diss}	20	mW

Output

Parameter	Test condition	Symbol	Value	Unit
Supply voltage		V_{CC}	- 0.5 to + 15	V
Output voltage		V_O	- 0.5 to + 15	V
Average output current		I_O	25	mA
Power dissipation		P_{diss}	100	mW

Coupler

Parameter	Test condition	Symbol	Value	Unit
Storage temperature range		T_{stg}	- 55 to + 125	°C
Ambient temperature range		T_{amb}	- 40 to + 85	°C
Lead soldering temperature	$t = 10\ \text{sec}$	T_s	260	°C
Isolation test voltage	$t = 1\ \text{s}$	V_{ISO}	5300	V_{RMS}
Pollution degree			2.0	
Creepage distance and clearance	Standard lead bending		7.0	mm
	Option 6, 7, 9		8.0	mm
Comparative tracking index per DIN IEC112/VDE 0303, part 1			175	
Isolation resistance	$V_{IO} = 500\ \text{V}$, $T_{amb} = 25\text{ °C}$	R_{IO}	10^{12}	Ω
	$V_{IO} = 500\ \text{V}$, $T_{amb} = 100\text{ °C}$	R_{IO}	10^{11}	Ω

Recommended Operating Conditions

A 0.1 μF bypass capacitor connected between pins 5 and 8 must be used.

Parameter	Test condition	Symbol	Min	Typ.	Max	Unit
Supply voltage		V_{CC}	4.5		15	V
Forward input current		I_{Fon}	1.6 ¹⁾		5.0	mA
		I_{Foff}			0.1	mA
Operating temperature		T_A	0		85	°C

¹⁾ We recommend using a 2.2 mA to permit at least 20 % CTR degradation guard band.



Electrical Characteristics

T_{amb} = 25 °C, unless otherwise specified

Minimum and maximum values are testing requirements. Typical values are characteristics of the device and are the result of engineering evaluation. Typical values are for information only and are not part of the testing requirements.

Input

0 °C ≤ T_{amb} ≤ 85 °C; 4.5 V ≤ V_{CC} ≤ 15 V; 1.6 mA ≤ I_{Fon} ≤ 5.0 mA; 2.0 ≤ V_{EH} ≤ 15 V; 0 ≤ V_{EL} ≤ 0.8 V; 0 mA ≤ I_{Foff} ≤ 0.1 mA

Typical values: T_{amb} = 25 °C; V_{CC} = 5.0 V; I_{Fon}=3.0 mA unless otherwise specified.

Parameter	Test condition	Symbol	Min	Typ.	Max	Unit
Forward voltage	I _F = 5.0 mA,	V _F		1.6	1.75	V
		V _F			1.8	V
Input current hysteresis	V _{CC} = 5 V, I _{HYS} = I _{Fon} - I _{Foff}			01		mA
Reverse current	V _R = 3.0 V	I _R		0.5	10	μA
Capacitance	V _R = 0 V, f = 1MHz	C _O		60		pF
Thermal resistance		R _{thja}		700		K/W

Output

Parameter	Test condition	Symbol	Min	Typ.	Max	Unit
Logic low output voltage	I _{OL} = 6.4 mA	V _{OL}			0.5	V
Logic high output voltage	I _{OH} = - 2.6 mA, *V _{OH} = V _{CC} - 1.8 V	V _{OH}	2.4	*		V
Output leakage current (V _{OUT} > V _{CC})	V _O = 5.5 V, V _{CC} = 4.5 V, I _F = 5.0 mA	I _{OHH}		0.5	100	μA
	V _O = 15 V, V _{CC} = 4.5 V, I _F = 5.0 mA	I _{OHH}		1.0	500	μA
Logic low supply current	V _{CC} = 5.5 V, I _F = 0	I _{CCL}		3.7	6.0	mA
	V _{CC} = 15 V, I _F = 0	I _{CCL}		4.1	6.5	mA
Logic high supply current	V _{CC} = 5.5 V, I _F = 5.0 mA	I _{CCH}		3.4	4.0	mA
	V _{CC} = 15 V, I _F = 5.0 mA	I _{CCH}		3.7	5.0	mA
Logic low short circuit output current	V _O = V _{CC} = 5.5 V, I _F = 0	I _{OSL} ⁽²⁾	25			mA
	V _O = V _{CC} = 15 V, I _F = 0	I _{OSL} ⁽²⁾	40			mA
Logic high short circuit output current	V _{CC} = 5.5 V, V _O = 0 V, I _F = 5.0 mA	I _{OSH} ⁽²⁾			- 10	mA
	V _{CC} = 15 V, V _O = 0 V, I _F = 5.0 mA	I _{OSH} ⁽²⁾			-25	mA
Thermal resistance				300		K/W

* Output short circuit time ≤ 10 ms.

Coupler

Parameter	Test condition	Symbol	Min	Typ.	Max	Unit
Capacitance (input-output)	f = 1.0 MHz, pins 1-4 and 5-8 shorted together	C _{IO}		0.6		pF

Switching Characteristics

$0\text{ }^{\circ}\text{C} \leq T_{\text{amb}} \leq 85\text{ }^{\circ}\text{C}$; $4.5\text{ V} \leq V_{\text{CC}} \leq 15\text{ V}$; $1.6\text{ mA} \leq I_{\text{Fon}} \leq 5.0\text{ mA}$; $0\text{ mA} \leq I_{\text{Foff}} \leq 0.1\text{ mA}$

Typical values: $T_{\text{amb}} = 25\text{ }^{\circ}\text{C}$; $V_{\text{CC}} = 5.0\text{ V}$; $I_{\text{Fon}} = 3.0\text{ mA}$ unless otherwise specified.

Parameter	Test condition	Symbol	Min	Typ.	Max	Unit
Propagation delay time to logic low output level	Without peaking capacitor	t_{PHL}		120		ns
	With peaking capacitor	t_{PHL}		115	300	ns
	Without peaking capacitor	t_{PLH}		125		ns
	With peaking capacitor	t_{PLH}		90	300	ns
Output rise time	10 % to 90 %	t_r		40		ns
Output fall time	90 % to 10 %	t_f		10		ns

Common Mode Transient Immunity

$T_{\text{amb}} = 25\text{ }^{\circ}\text{C}$, $V_{\text{CC}} = 5\text{ V}^{(4)}$

Parameter	Test condition	Part	Symbol	Min	Typ.	Max	Unit
Logic high common mode transient immunity ⁽⁴⁾	$ V_{\text{CM}} = 50\text{ V}$, $I_{\text{F}} = 1.6\text{ mA}$	SFH6731	$ CM_{\text{H}} $	1000			V/ μs
	$ V_{\text{CM}} = 300\text{ V}$, $I_{\text{F}} = 1.6\text{ mA}$	SFH6732	$ CM_{\text{H}} $	5000			V/ μs
Logic low common mode transient immunity ⁽⁴⁾	$ V_{\text{CM}} = 50\text{ V}$, $I_{\text{F}} = 0\text{ mA}$	SFH6731	$ CM_{\text{L}} $	1000			V/ μs
	$ V_{\text{CM}} = 1000\text{ V}$, $I_{\text{F}} = 0\text{ mA}$	SFH6732	$ CM_{\text{L}} $	10000			V/ μs

⁽⁴⁾ CMH is the maximum slew rate of a common mode voltage VCM at which the output voltage remains at logic high level ($V_{\text{O}} > 2.0\text{ V}$). CML is the maximum slew rate of a common mode voltage VCM at which the output voltage remains at logic low level ($V_{\text{O}} < 0.8\text{ V}$).

Typical Characteristics ($T_{\text{amb}} = 25\text{ }^{\circ}\text{C}$ unless otherwise specified)

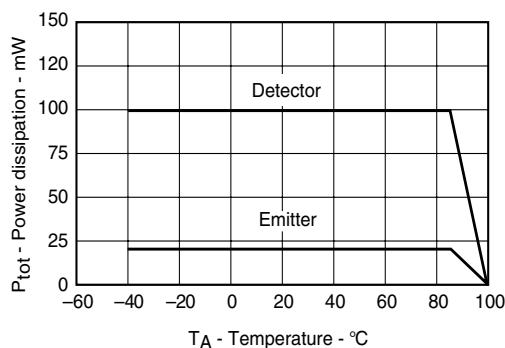

isfh6731_01

Figure 1. Permissible Total Power Dissipation vs. Temperature

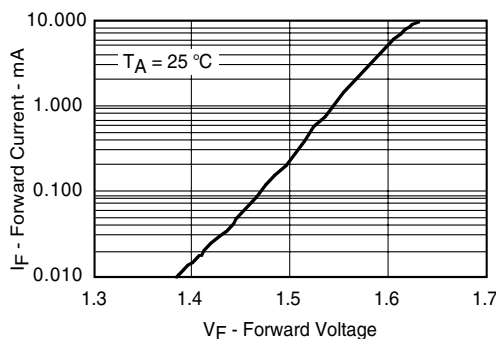

isfh6731_02

Figure 2. Typical Input Diode Forward Current vs. Forward Voltage

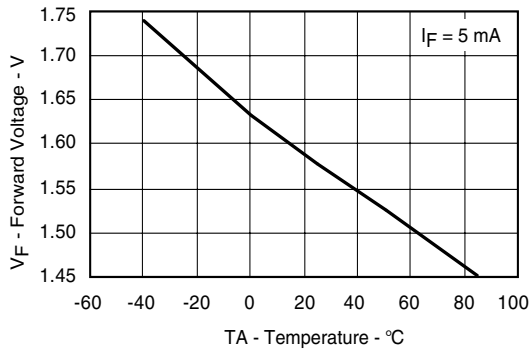

isfh6731_03

Figure 3. Typical Forward Input Voltage vs. Temperature

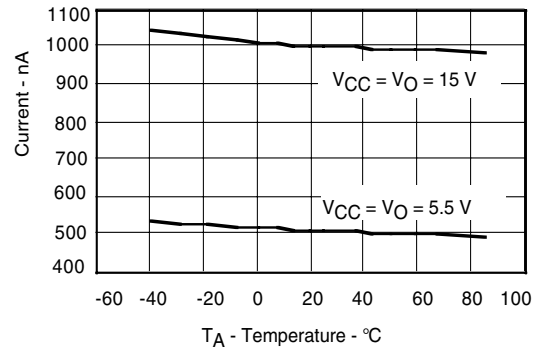

'31_06

Figure 6. Typical Output Leakage Current vs. Temperature

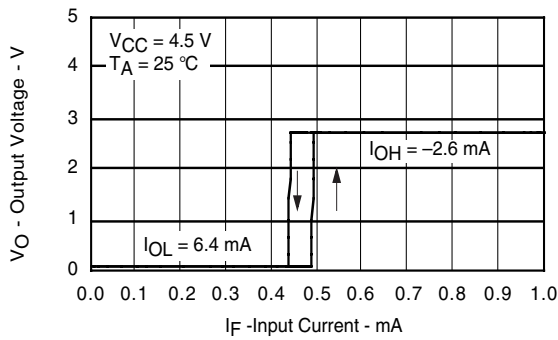

isfh6731_04

Figure 4. Typical Output Voltage vs. Forward Input Current

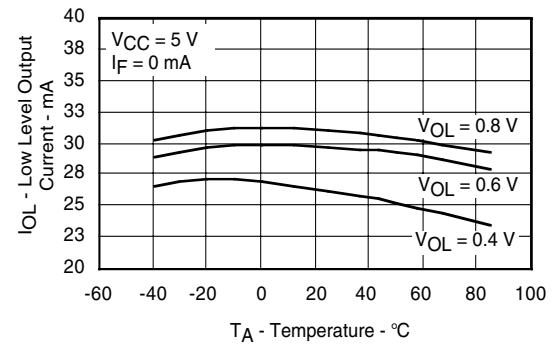

isfh6731_07

Figure 7. Typical Low Level Output Current vs. Temperature

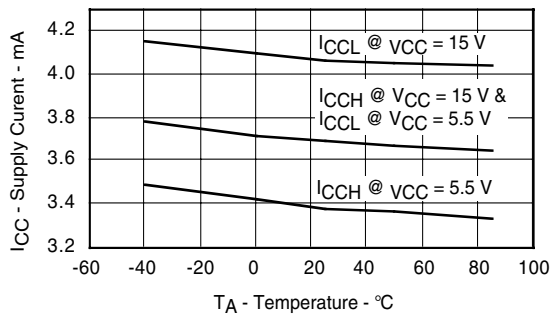

isfh6731_05

Figure 5. Typical Supply Current vs. Temperature

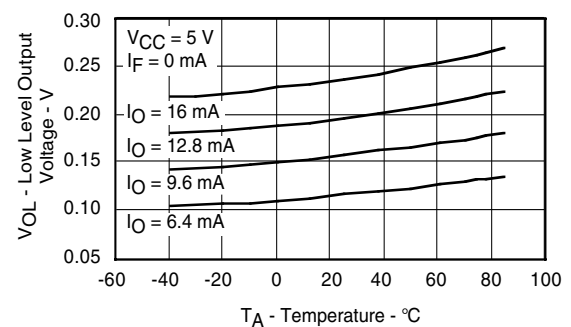

isfh6731_08

Figure 8. Typical Low Level Output Voltage vs. Temperature

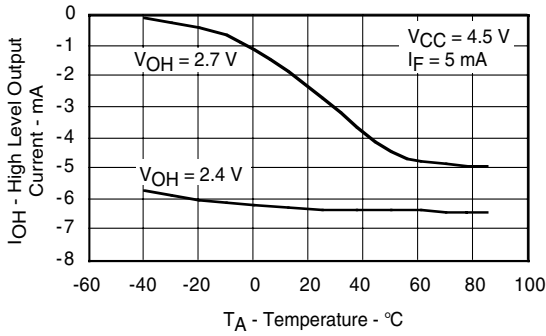

isfh6731_09

Figure 9. Typical High Level Output Current vs. Temperature

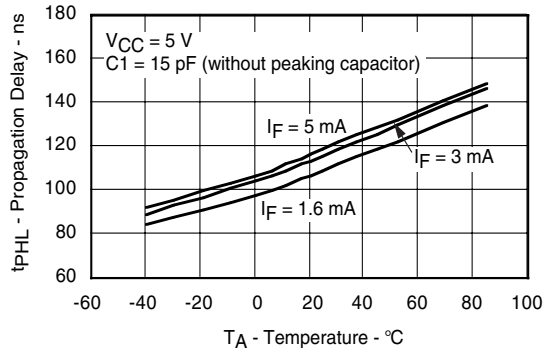

isfh6731_12

Figure 12. Typical Propagation Delays to Logic Low vs. Temperature

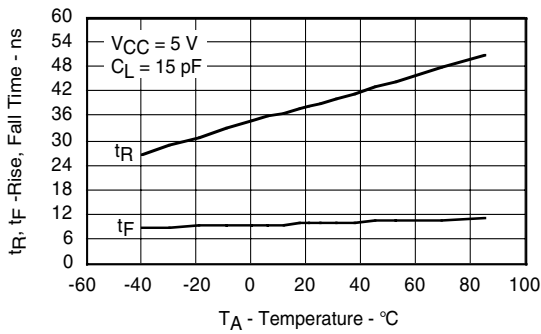

isfh6731_10

Figure 10. Rise and Fall Time vs. Ambient Temperature

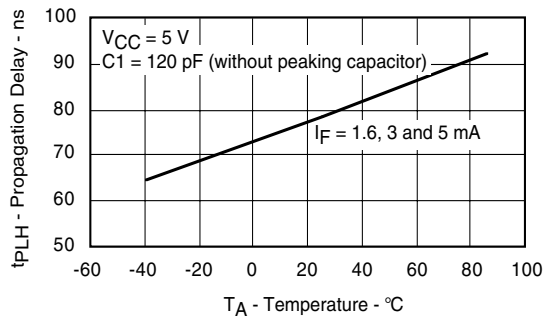

isfh6731_13

Figure 13. Typical Propagation Delays to Logic High vs. Temperature

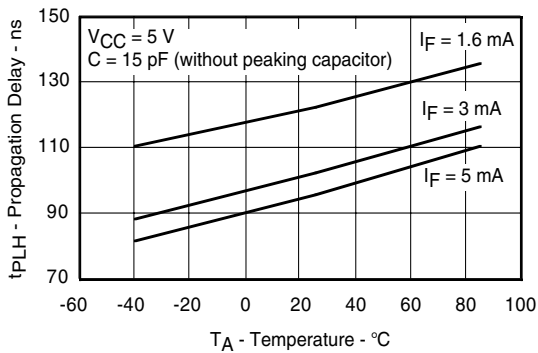

isfh6731_11

Figure 11. Typical Propagation Delays to Logic High vs. Temperature

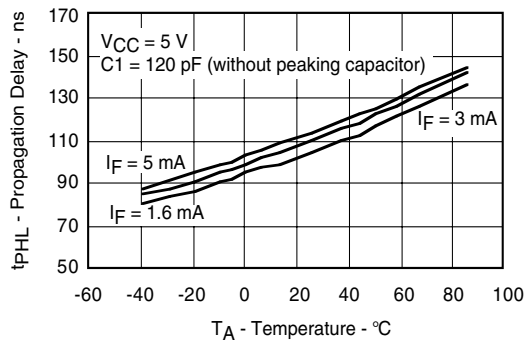

isfh6731_14

Figure 14. Typical Propagation Delays to Logic Low vs. Temperature

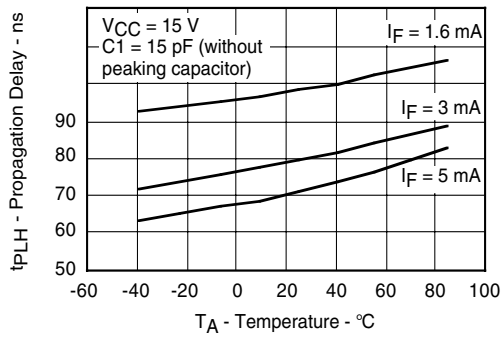

isfh6731_15

Figure 15. Typical Propagation Delays to Logic High vs. Temperature

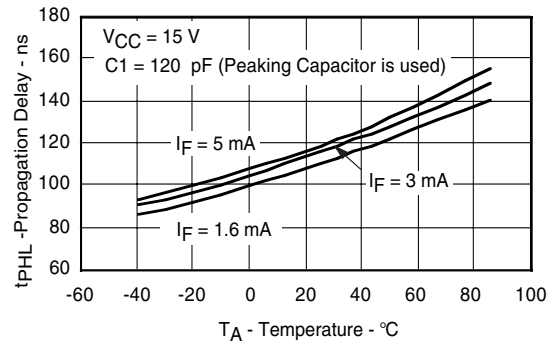

isfh6731_18

Figure 18. Typical Propagation Delays to Logic Low vs. Temperature

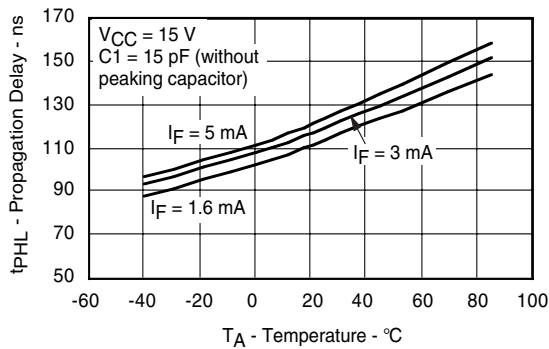

isfh6731_16

Figure 16. Typical Propagation Delays to Logic Low vs. Temperature

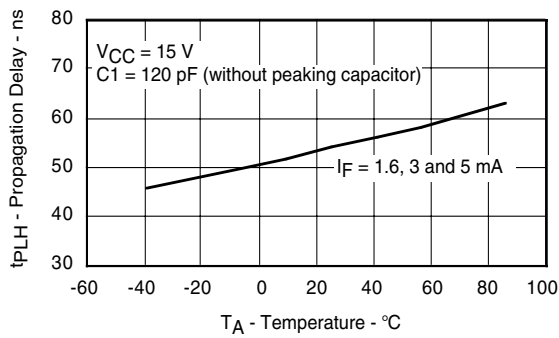

isfh6731_17

Figure 17. Typical Propagation Delays to Logic High vs. Temperature

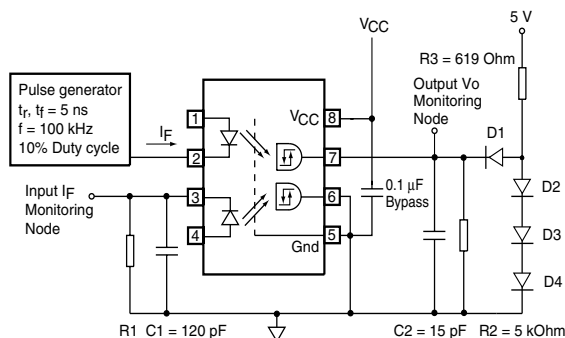

The Probe and Jig Capacitances are included in C1 and C2 All diodes are 1N916 or 1N3064

R1	2.15 kOhm	1.1 kOhm	681 Ohm
I _F (ON)	1.6 mA	3 mA	5 mA

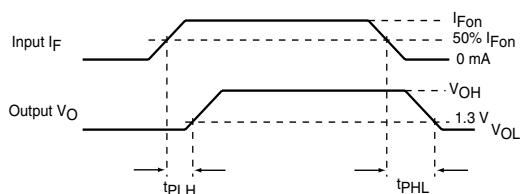

ish6731_19

Figure 19. Test Circuit for t_{pLH} , t_{pHL} , t_r and t_f

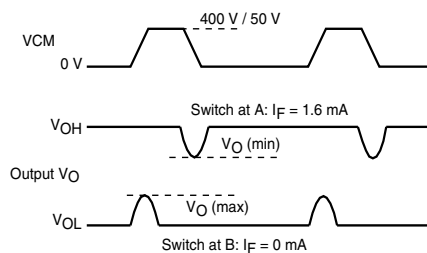
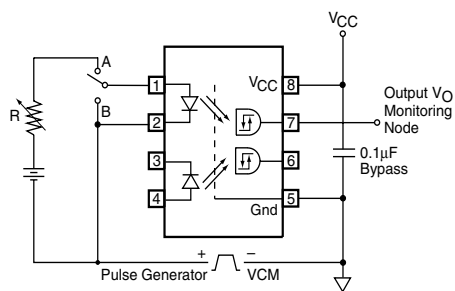

ish6731_20

Figure 20. Test Circuit for Common Mode Transient Immunity and Typical Waveforms

Package Dimensions in Inches (mm)

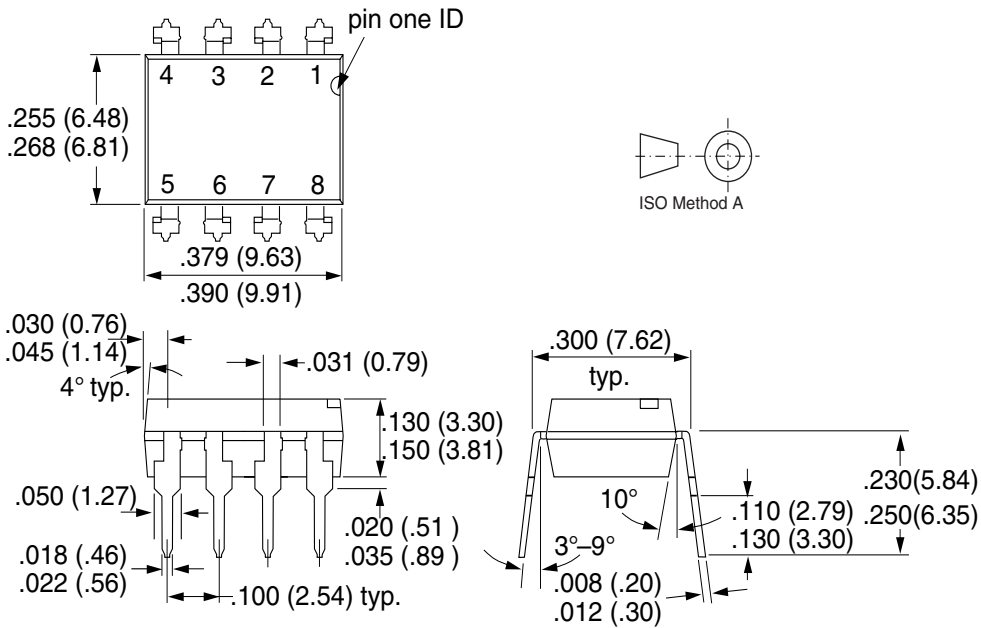

i178006

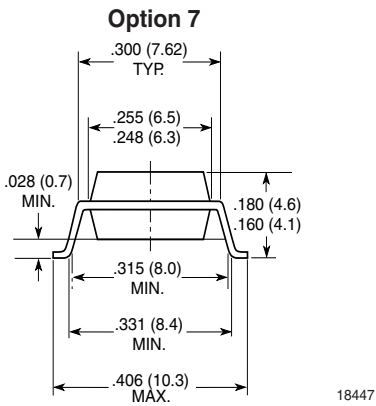

18447

Ozone Depleting Substances Policy Statement

It is the policy of Vishay Semiconductor GmbH to

1. Meet all present and future national and international statutory requirements.
2. Regularly and continuously improve the performance of our products, processes, distribution and operating systems with respect to their impact on the health and safety of our employees and the public, as well as their impact on the environment.

It is particular concern to control or eliminate releases of those substances into the atmosphere which are known as ozone depleting substances (ODSs).

The Montreal Protocol (1987) and its London Amendments (1990) intend to severely restrict the use of ODSs and forbid their use within the next ten years. Various national and international initiatives are pressing for an earlier ban on these substances.

Vishay Semiconductor GmbH has been able to use its policy of continuous improvements to eliminate the use of ODSs listed in the following documents.

1. Annex A, B and list of transitional substances of the Montreal Protocol and the London Amendments respectively
2. Class I and II ozone depleting substances in the Clean Air Act Amendments of 1990 by the Environmental Protection Agency (EPA) in the USA
3. Council Decision 88/540/EEC and 91/690/EEC Annex A, B and C (transitional substances) respectively.

Vishay Semiconductor GmbH can certify that our semiconductors are not manufactured with ozone depleting substances and do not contain such substances.

We reserve the right to make changes to improve technical design
and may do so without further notice.

Parameters can vary in different applications. All operating parameters must be validated for each customer application by the customer. Should the buyer use Vishay Semiconductors products for any unintended or unauthorized application, the buyer shall indemnify Vishay Semiconductors against all claims, costs, damages, and expenses, arising out of, directly or indirectly, any claim of personal damage, injury or death associated with such unintended or unauthorized use.

Vishay Semiconductor GmbH, P.O.B. 3535, D-74025 Heilbronn, Germany
Telephone: 49 (0)7131 67 2831, Fax number: 49 (0)7131 67 2423